

Water Specialist CI Control Valve Programming Manual

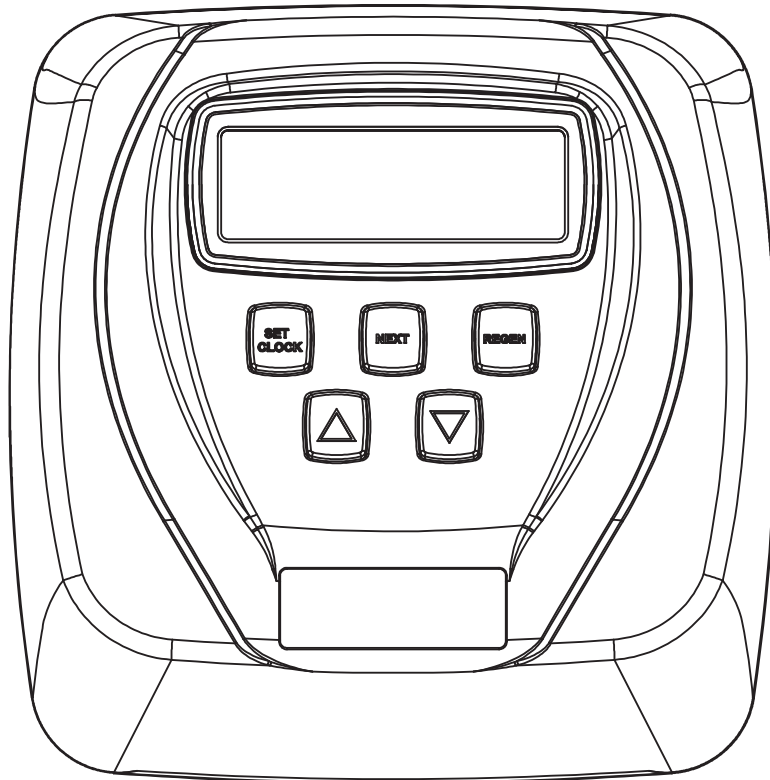

Table of Contents

CI Front Cover and Drive Assembly	4
OEM General Instructions	5
OEM Cycle Sequence	6
OEM Softener System Setup	11
Setting Options Table.....	14
OEM Filter System Setup	15
Installer Display Settings	18
User Display Settings	19
Diagnostics	22
Valve History	24

Front Cover and Drive Assembly

Drawing No.	Order No.	Description	Quantity
1	V3175CI-01	WS1CI FRONT COVER ASSEMBLY	1
2	V3107-01	WS1 MOTOR	1
3	V3002-A	WS1 DRIVE BRACKET ASY	1
4	V3108CI-06BOARD	WS1 THRU 2 CI PCB XMEGA REPL	1
5	V3110	WS1 DRIVE REDUCING GEAR 12X36	3
6	V3109	WS1 DRIVE GEAR COVER	1
Not Shown	V3186-06	WS1 POWER SUPPLY US 15VDC HOCP	1
	V3186EU-06	WS1 POWER SUPPLY EU 15VDC HOCP	
	V3186UK-06	WS1 POWER SUPPLY UK 15VDC HOCP	
	V3186-01	WS1 POWER CORD ONLY	
Not Shown	V3178	WS1 DRIVE BACKPLATE	1

Power Supply	U.S.	International
Supply Voltage	100-120 VAC	100-240 VAC
Supply Frequency	50/60 Hz	50/60 Hz
Output Voltage	15 VDC	15 VDC
Output Current	500 mA	500 mA

Relay Driver Output Type – Dual Solid-State 12VDC “wet” contacts - N.O.
 Relay Driver Output Capacity - 12VDC @100mA per relay output (total current through both outputs not to exceed 200mA).

NOTE: Check for proper mounting dimensions on valve backplate prior to mounting an external relay under control cover

Wiring for Correct On/Off Operation	
PC Board Relay Terminal Block	Relay
RLY 1	Coil -
+ COM	Coil +
RLY 2	Coil -

When replacing the battery, align positives and push down to fully seat.

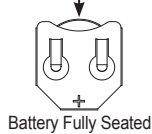

Correct Battery Orientation

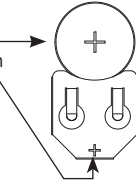

Battery replacement is 3 volt lithium coin cell type 2032.

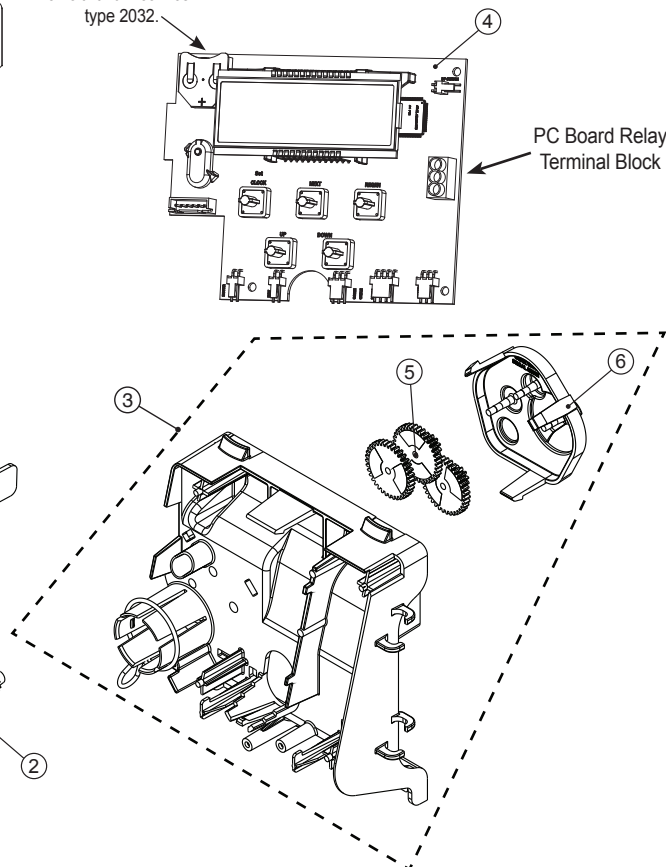
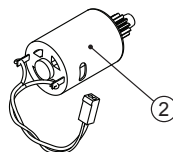
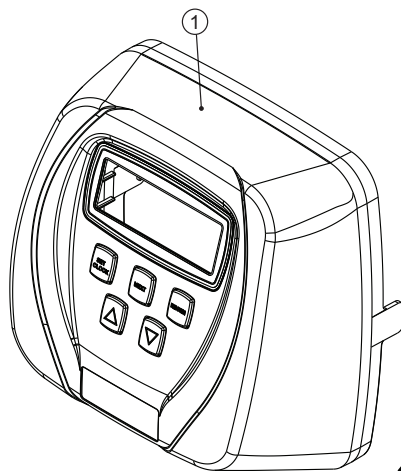

OEM General Instructions

The control valve offers multiple procedures that allow the valve to be modified to suit the needs of the installation. These procedures are:

- OEM Cycle Sequence
- OEM Softener System Setup
- OEM Filter System Setup
- Installer Display Settings
- User Display Settings
- Diagnostics
- Valve History

Once the OEM Cycle Sequence has been set, the other procedures can be accessed in any order. Details on each of the procedures are provided on the following pages.

To “lock out” access to diagnostic and valve history displays and modifications to settings except hardness, day override, time of regeneration and time of day by anyone but the manufacturer, press ▼, NEXT, ▲, and SET CLOCK in sequence after settings are made. To “unlock”, so other displays can be viewed and changes can be made, press ▼, NEXT, ▲, and SET CLOCK in sequence.

When in operation normal user displays such as time of day, volume remaining before regeneration, present flow rate or days remaining before regeneration are shown. When stepping through a procedure, if no buttons are pressed within five minutes, the display returns to a normal user display. Any changes made prior to the five minute time out are incorporated.

To quickly exit OEM Softener Setup, OEM Filter Setup, Installer Display Settings, Diagnostics or Valve History press SET CLOCK. Any changes made prior to the exit are incorporated.

When desired, all programming and all information in Diagnostics may be reset to defaults when the valve is installed in a new location. To reset to defaults, press NEXT and ▼ simultaneously to go to the Softening/Filtering screen. Press ▲ and ▼ simultaneously to reset diagnostic values and all programming to defaults. Screen will return to User Display.

Sometimes it is desirable to have the valve initiate and complete two regenerations within 24 hours and then return to the preset regeneration procedure. It is possible to do a double regeneration if the control valve is set to “NORMAL” or “NORMAL + on 0” in OEM Softener System Setup or OEM Filter System Setup. To do a double regeneration:

1. Press the REGEN button once. REGEN TODAY will flash on the display.
2. Press and hold the REGEN button for three seconds until the valve regeneration initiates.

Once the valve has completed the immediate regeneration, the valve will regenerate one more time at the preset regeneration time.

For Valve Type 1.0Γ, press and hold SET CLOCK and ▲ for about 3 seconds to initiate an exchange of the tank in Service without cycling the regeneration valve. After tank switch, days remaining and capacity remaining status is retained for each tank until the next regeneration.

Prior to selecting the upflow regeneration cycle, verify that the correct body, main piston, regenerant piston and stack are being used, and that the injector plug(s) are in the correct location. Refer to the Service Manual for drawings and part numbers.

OEM Cycle Sequence

OEM Cycle Sequence instructions allows the OEM to set the order of the cycle. The OEM Softener System Setup or the OEM Filter System Setup allow the OEM to set how long cycles will last. The OEM may choose up to 9 cycles in any order.

Cycle Options			
BACKWASH	DN BRINE	FILL	END
RINSE	UP BRINE	SOFTENING OR FILTERING	

END must be used as the last cycle option. The SERVICE cycle should only be used in brine prefill applications.

The following is an example of how to set a valve so that when regeneration is initiated BACKWASH occurs first, dn BRINE occurs second, RINSE occurs third, and FILL occurs fourth.

STEP 1CS

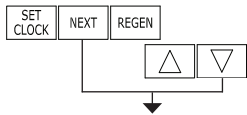

Step 1CS – Press NEXT and ▼ simultaneously for 3 seconds and release. Then press NEXT and ▼ simultaneously for 3 seconds and release. If screen in Step 2CS does not appear in 5 seconds the lock on the valve is activated. To unlock press ▼, NEXT, ▲, and SET CLOCK in sequence, then press NEXT and ▼ simultaneously for 3 seconds and release. Then press NEXT and ▼ simultaneously for 3 seconds and release.

STEP 2CS

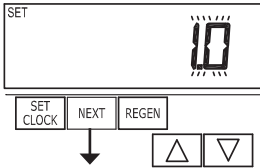

Step 2CS – Use ▲ or ▼ to select 1.0 for WS1 valve, 1.25 for WS1.25 valve, 1.5 for WS1.5 valve, 2.0 for WS2 or 1.0Γ for a twin valve.

STEP 3CS

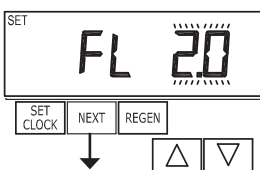

Step 3CS – When 1.5 or 2.0 is selected, an additional screen will appear. It is used to select which size flow meter is to be used with the valve, 1.5”, 2.0” or 3.0”. Variable meter pulses of 0.1-150.0 PPL can also be selected. Press NEXT to go to Step 4CS. Press REGEN to return to previous step.



STEP 4CS

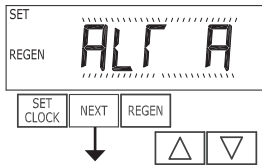

Step 4CS – Allows selection of one of the following using ▲ or ▼:

- the Control Valve to have no hard water bypass;
- the Control Valve to act as an alternator; or
- the Control Valve to have a separate source during the regeneration cycle; or
- the Control Valve to operate with the Clack System Controller.

Select OFF when none of these features are used.

This display will not appear if 1.0Γ was selected in Step 2CS.

Only use Clack No Hard Water Bypass Valves or Clack Motorized Alternating Valves (MAV) with these selections. Clack No Hard Water Bypass Valves (1” or 1.25” V3070FF or V3070FM) are not designed to be used with the alternator or separate source functions.



Configuring the Control Valve for No Hard Water Bypass Operation:

Select nHbP for control operation. For no hard water bypass operation the three wire communication connector is not used.

Selection requires that a connection to MAV or a Clack No Hard Water Bypass Valve is made to the two pin connector labeled MAV located on the printed circuit board. If using a MAV, the A port of the MAV must be plugged and the valve outlet connected to the B port. When set to nHbP the MAV will be driven closed before the first regeneration cycle that is not FILL or SOFTENING or FILTERING, and be driven open after the last regeneration cycle that is not FILL.

NOTE: If the control valve enters into an error state during regeneration mode, the no hard water bypass valve will remain in its current state until the error is corrected and reset.



Configuring the Control Valve for Separate Source Operation:

Select SEPS for control operation. For separate source operation the three wire communication connector is not used.

Selection requires that a connection to a Clack Motorized Alternator Valve (MAV) is made to the two pin connector labeled MAV located on the printed circuit board. The C port of the MAV must be connected to the valve inlet and the A port connected to the separate source used during regeneration. The B port must be connected to the feed water supply.

When set to SEPS the MAV will be driven closed before the first regeneration cycle, and be driven open after the last regeneration cycle.

NOTE: If the control valve enters into an error state during regeneration mode, the MAV will remain in its current state until the error is corrected and reset.

Selecting the Control Valve to act as an alternator:

Software Rev Level 320.0 and higher = Use 3-wire Interconnect Cable for all communication between units.

Software Rev Level 319.5 and lower = Use 2-wire Interconnect Cables for twin alternators with independent flow meters.

Prior to starting the programming steps, connect the interconnect cable to each control valve board's three pin connector labeled 'COMM CABLE'. Also connect the meter cord to either control valve to the three pin connector labeled 'METER'.			
Softener Valve Programming Steps			
OEM Cycle Sequence	Step 4CS	Set to ALT A Connect ALT A valve to the MAV's A port and connect the MAV's two pin wire connector to the two pin connector labeled "DRIVE" on the ALT A valve	Set to ALT b Connect ALT b valve to the MAV's B port. No connections between the ALT b valve and the MAV are made.
Softener System Setup	Step 7S	Set Volume Capacity	Set Volume Capacity
Softener System Setup	Step 8S	Set to 'AUTO'	Set to 'AUTO'
Softener System Setup	Step 9S	Set regeneration time option to 'on 0'.	Set regeneration time option to 'on 0'.
Installer Display Setting	Step 4I	Set Day Over ride to "oFF"	Set Day Over ride to "oFF"

If set up for a filter, in Step 7F set Volume Capacity in M³; in Step 8F select Regeneration Time Option “on 0”; and in Step 4I select Day Override “oFF”.

NOTE: If the control valve is in an error state during regeneration mode the MAV will close the B port and keep open the A port until the error is corrected and reset.

For Clack Corporation alternator systems using **WS1, WS1.25 and WS1.5** valves there will be an option to delay the last two cycles of regeneration (only “Rinse” and “Fill”). This feature splits the regeneration into two portions. The first portion of the regeneration will start immediately and all programmed cycles before the “Rinse” and “Fill” cycles will be performed. After all programmed cycles before “Rinse” and “Fill” are completed the control valve will drive to the service position (displaying “Delayed Rinse + Fill Pending”). When the volume of the on-line unit is depleted to 10% of its programmed capacity, the control valve will be triggered to finish the second portion of the regeneration. Once “Rinse” and “Fill” are completed, the valve will re-enter Standby mode until requested to come on-line for Service.

For Clack Corporation alternator systems using the **WS2** valve, when NEXT is pressed after selecting ALT A or ALT b, a display will allow the user to set the amount of pre-service rinse time for the stand by tank just prior to returning to service. With 1.0Γ set, this same display appears and is set in a similar manner.

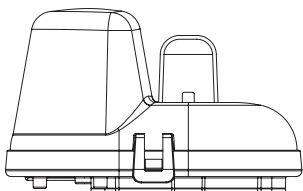
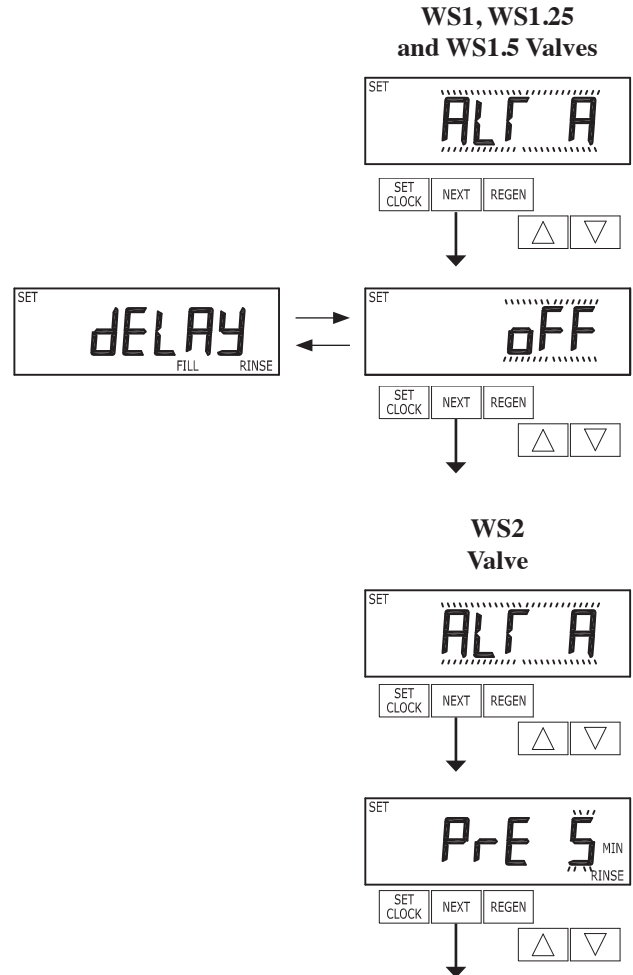

Retracted

Valve “A” in Service Position = MAV piston rod Retracted

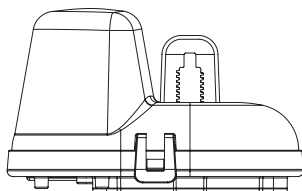

Extended

Valve “B” in Service Position = MAV piston rod Extended

Note: Clack Twin Alternator Operations

- Twin alternating systems can be programmed with a day override setting combined with the normal volume-based regeneration programming. A twin alternating system in this configuration will then regenerate based on the volume used or the day override if there is a period of low water usage.
- Twin alternating systems can be programmed as a time clock only based regenerating system. In this configuration, the days remaining are counted only on the unit that is in service. The unit in Stand-by Mode only notes days in diagnostics, which results in time clock only twin regeneration initiation.
- Twin alternating systems can be programmed for a delayed regeneration time. The system will allow an immediate transfer of the MAV to switch tanks and place a fully regenerated unit in service once a unit becomes exhausted. The exhausted unit will then be placed into Stand-by Mode and allowed to have a delayed regeneration at the pre-set time.

Configuring the Control Valve to operate with Clack System Controller:

Select SYS to link the Control Valve to the Clack System Controller. For communication between the Control Valve and the System Controller, a three-wire communication cable is required. Press NEXT to go to Step 5CS. Press REGEN to return to previous step.



STEP 5CS

Step 5CS – Allows selection of one of the following using ▲ or ▼:

- an outside signal to initiate a regeneration;
- an outside signal to prevent or delay regeneration.

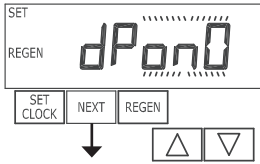

Selection only matters if a connection is made to the two pin connector labeled DP SWITCH located on the printed circuit board. Following is an explanation of the options:

OFF - Feature not used.

NOTE: In a twin alternating system each control must have a separate dP signal or dP switch. One dP signal or one dP switch cannot be used for both controls.

dPon0 – If the dP switch is closed for an accumulative time of 2 minutes a regeneration will be signaled to the unit. In a twin alternating system the MAV will transition first to switch units so that the signaled unit can start regeneration. After the MAV has fully transitioned, the regeneration begins immediately. Note: For WS1 – WS1.5 control valves programmed for twin alternating: if the dP function “dPon0” is set, the Delayed Rinse and Fill feature is not available.

dPdEL – If the dP switch is closed for an accumulative time of 2 minutes a regeneration will occur at the scheduled delayed regeneration time. In a twin alternating system, once the dP switch is triggered the PC board will display REGEN TODAY and switch tanks immediately. At the Delayed Regeneration Time, the triggered unit will then regenerate. Note: For WS1 – WS1.5 control valves programmed for twin alternating: if the dP function “dPdEL” is set, the Delayed Rinse and Fill feature is not available.

HoLd – If the dP switch is closed a regeneration will be prevented from occurring while there is switch closure. In a twin alternating system the regeneration of a unit can be prevented upon switch closure. If the unit depletes the capacity down to zero, it will not be allowed to switch tanks to regenerate until the switch is open. Note: For WS1 – WS1.5 control valves programmed for twin alternating the Delayed Rinse and Fill feature can be set in conjunction with the “HoLd” if desired.

Press NEXT to go to Step 6CS. Press REGEN to return to previous step.

STEP 6CS

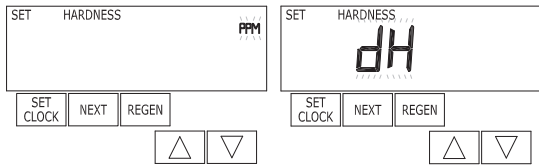

Step 6CS – Determine the measurement to calculate volumetric capacity. The choices are:

- ppm** parts per million
- FH** French degrees
- dH** German degrees

NOTE: If control is going to be used in a filter application none of these settings can be used. Press NEXT to go to Step 7CS. Press REGEN to return to previous step.

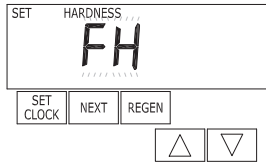

STEP 7CS

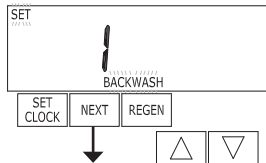

Step 7CS – Press ▲ or ▼ until BACKWASH appears. Press NEXT to go to Step 8CS. Press REGEN to return to previous step.

STEP 8CS

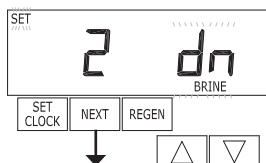

Step 8CS - Press ▲ or ▼ until BRINE appears. **NOTE:** Prior to selecting the upflow regeneration cycle, verify that the correct body, main piston, regenerant piston and stack are being used, and that the injector plug(s) are in the correct location. Refer to the Service Manual for drawings and part numbers. Press NEXT to go to Step 9CS. Press REGEN to return to previous step.

STEP 9CS

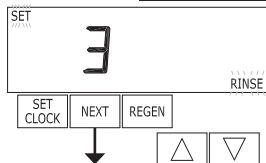

Step 9CS - Press ▲ or ▼ until RINSE appears. Press NEXT to go to Step 10CS. Press REGEN to return to previous step.

STEP 10CS

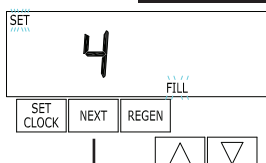

Step 10CS - Press ▲ or ▼ until FILL appears. Press NEXT to go to Step 11CS. Press REGEN to return to previous step.

STEP 11CS

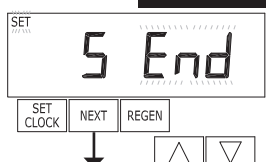

Step 11CS - Press ▲ or ▼ until END appears. Press NEXT to go to Step 12CS. Press REGEN to return to previous step.

STEP 12CS

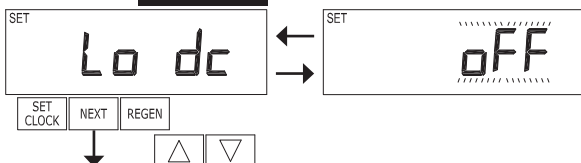

Step 12CS - Battery operation. Set to OFF when using a wall adapter. Set to ON when operating valve with a 12VDC deep cycle automotive-style battery. Press NEXT to go to Step 13CS. Press REGEN to return to previous step.

STEP 13CS

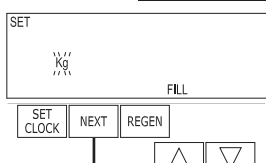

Step 13CS - Fill Units: If set as a softener, if Step 2CS is set to 1.5, and FILL is part of the Regeneration Cycle Sequence, FILL UNITS of MIN or kg can be selected. Press NEXT to exit OEM Cycle Sequence. Press REGEN to return to previous step.

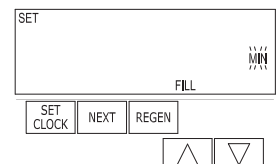

RETURN TO NORMAL MODE

OEM Softener System Setup

In OEM Softener System Setup the OEM chooses the time for the cycles selected in OEM Cycle Sequence and specifies other operating parameters for the system. The upper and lower limits of the allowable values for the cycles are as follows:

Cycle Options	Units	Lower/Upper Limit
Backwash	Minutes	1 to 120
Rinse (fast)	Minutes	1 to 120
dn Brine (combination of brining and slow rinse)	Minutes	1 to 180
up Brine (combination of brining and slow rinse)	Minutes	1 to 180
Fill for 1", 1.25" and 1.5"	kg	0.05 to 90.00
Fill for WS2 valves or WS1.5 set to MIN	Minutes	0.1 to 99.0
Service	Minutes	1 to 480

Since no time is associated with the END cycle, the END cycle will not appear in the OEM Softener System Setup sequence.

STEP 1S

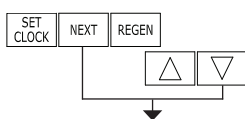

Step 1S – Press NEXT and ▼ simultaneously for 3 seconds and release. If screen in Step 2S does not appear in 5 seconds the lock on the valve is activated. To unlock press ▼, NEXT, ▲, and SET CLOCK in sequence, then press NEXT and ▼ simultaneously for 3 seconds and release.

STEP 2S

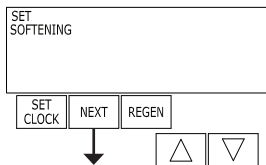

Step 2S – Choose SOFTENING using ▲ or ▼. Press NEXT to go to Step 3S. Press REGEN to exit OEM Softener System Setup.

STEP 3S

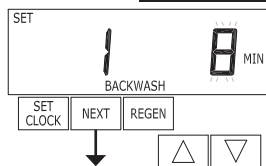

Step 3S – Select the time for the first cycle (which in this example is BACKWASH) using ▲ or ▼. Press NEXT to go to Step 4S. Press REGEN to return to previous step.

STEP 4S

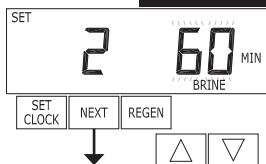

Step 4S – Select the time for the second cycle (which in this example is dn BRINE) using ▲ or ▼. Press NEXT to go to Step 5S. Press REGEN to return to previous step.
NOTE: The display will flash between cycle number and time, and brine direction (dn).

STEP 5S

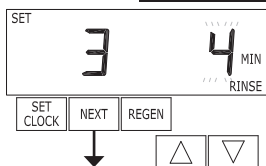

Step 5S – Select the time for the third cycle (which in this example is RINSE) using ▲ or ▼. Press NEXT to go to Step 6S. Press REGEN to return to previous step.

STEP 6S

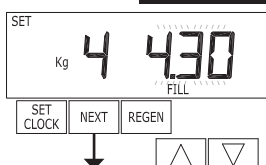

Step 6S – Select the kg or MIN for the fourth cycle (which in this example is FILL) using ▲ or ▼. When 2.0 is selected in Step 2CS, or MIN is selected in Step 12CS, FILL is in minutes. WS2 valves are shipped from the factory with a refill flow control of 2.2 gpm (8.3 lpm). Press NEXT to go to Step 7S. Press REGEN to return to previous step.

STEP 7S

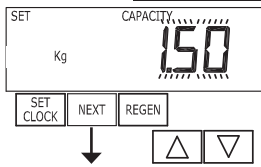

Step 7S – Set System Capacity using ▲ or ▼. See chart. The System Capacity setting should be based on the volume of resin and Kg of salt fill set in Step 6S. When using ppm, dH, or FH the system capacity and hardness levels entered are used to determine the Volume Capacity. Press NEXT to go to Step 8S. Press REGEN to return to previous step.

Setting	Units
PPM	Kg of CaCO ₃
dH or FH	M ³

STEP 8S

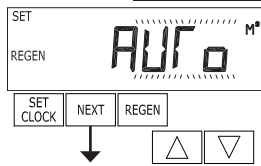

Step 8S – Set Volume Capacity using ▲ or ▼. If value is set to:

- AUTO capacity will be automatically calculated and reserve capacity will be automatically estimated;
- oFF regeneration will be based solely on the day override set (see Installer Display/Settings Step 4I);
- a number, regeneration initiation will be based on the value specified (in M³); or

If oFF or a number is used, hardness display will not be allowed to be set in Installer Display Settings Step 2I & 3I. See Setting Options Table for more detail. Press NEXT to go to Step 9S. Press REGEN to return to previous step.

STEP 9S

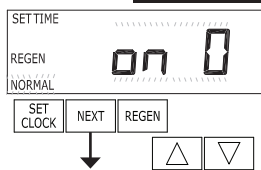

Step 9S – Set Regeneration Time Options using ▲ or ▼. If value is set to:

- NORMAL means regeneration will occur at the preset time;
- on 0 means regeneration will occur immediately when the volume capacity reaches 0 (zero); or
- NORMAL + on 0 means regeneration will occur at one of the following:
 - the preset time when the volume capacity falls below the reserve or the specified number of days between regenerations is reached whichever comes first; or
 - immediately after 10 minutes of no water usage when the volume capacity reaches 0 (zero).

NORMAL is the default if Step 4CS is set to ALT A or ALT b, and NORMAL + on 0 is not available. On 0 is the default if Step 2CS is set to 1.0Γ, and NORMAL + on 0 is not available. This step will not appear if Step 8S is set to off or Step 4CS is set to SYS. See Setting Options Table for more detail. Press NEXT to go to Step 10S. Press REGEN to return to previous step.

STEP 10S

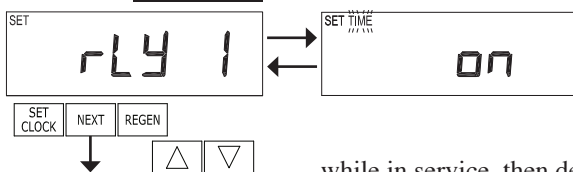

Step 10S – Set Relay 1 operation using ▲ or ▼. The choices are:

- Set Time on: Relay activates after a set time at the beginning of a regeneration cycle and then deactivates after a set period of time. The start of regeneration is defined as the first backwash cycle or Dn brine/Up brine cycle, whichever comes first.
- Set L Softening on: Relay activates after a set volume has been used while in service, then deactivates after the meter stops registering flow and the set time period has expired.

while in service, then deactivates after the meter stops registering flow and the set time period has expired.

- Set L Softening Regen on: Relay activates after a set volume has been used while in service or during regeneration, then deactivates after the meter stops registering flow and the set time period has expired.

- Set Off: If set to Off, Steps 11S and 12S will not be shown.

Press NEXT to go to Step 11S. Press REGEN to return to previous step.

STEP 11S

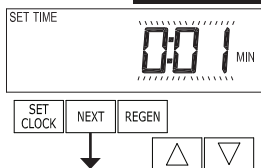

Step 11S – Set Relay 1 Actuation Time or Liters using ▲ or ▼. The choices are:

- Relay Actuation Time: After the start of a regeneration the amount of time that should pass prior to activating the relay. The start of regeneration is defined as the first backwash cycle or Dn brine cycle, whichever comes first. Ranges from 1 second to 200 minutes.
- Relay Actuation Liters: Relay activates after a set number of Liters has passed through the meter when the valve is in the Service mode. Ranges from 1 to 200 Liters.

Press NEXT to go to Step 12S. Press REGEN to return to previous step.

STEP 12S

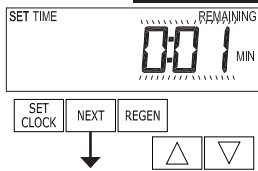

Step 12S – Set Relay 1 Deactivate Time using ▲ or ▼.

- If Set Time on is selected in Step 10S the relay will deactivate after the time set has expired. Ranges from 1 second to 200 minutes.
 - If Set L on or Set L Softening Regen on is selected in Step 10S the relay will deactivate after the time set has expired or after the meter stops registering flow, whichever comes first. Ranges from 1 second to 20 minutes.
- Press NEXT to go to Step 13S. Press REGEN to return to previous step.

STEP 13S

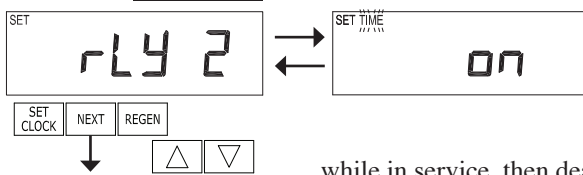

Step 13S – Set Relay 2 operation using ▲ or ▼. The choices are:

- Set Time on: Relay activates after a set time at the beginning of a regeneration cycle and then deactivates after a set period of time. The start of regeneration is defined as the first backwash cycle or Dn brine cycle, whichever comes first.
 - Set L Softening on: Relay activates after a set volume has been used while in service, then deactivates after the meter stops registering flow and the set time period has expired.
 - Set L Softening Regen on: Relay activates after a set volume has been used while in service or during regeneration, then deactivates after the meter stops registering flow and the set time period has expired.
 - Error: Relay closes whenever the control enters the Error Mode, and immediately deactivates when the error mode is exited.
 - Set Off: If set to Off, Steps 14S and 15S will not be shown.
- Press NEXT to go to Step 14S. Press REGEN to return to previous step.

STEP 14S

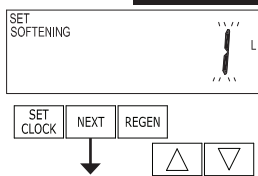

Step 14S – Set Relay 2 Actuation Time or Liters using ▲ or ▼. The choices are:

- Relay Actuation Time: After the start of a regeneration the amount of time that should pass prior to activating the relay. The start of regeneration is defined as the first backwash cycle or Dn brine/Up brine cycle, whichever comes first. Ranges from 1 second to 200 minutes.
 - Relay Actuation Liters: Relay activates after a set number of Liters has passed through the meter when the valve is in the Service mode. Ranges from 1 to 200 Liters.
- Press NEXT to go to Step 15S. Press REGEN to return to previous step.

STEP 15S

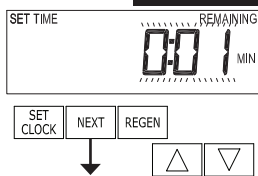

Step 15S – Set Relay 2 Deactivate Time using ▲ or ▼.

- If Set Time on is selected in Step 13S the relay will deactivate after the time set has expired. Ranges from 1 second to 200 minutes.
 - If Set L on or Set L Softening Regen on is selected in Step 13S the relay will deactivate after the time set has expired or after the meter stops registering flow, whichever comes first. Ranges from 1 second to 20 minutes.
- Press NEXT to go to Step 16S. Press REGEN to return to previous step.

STEP 16S

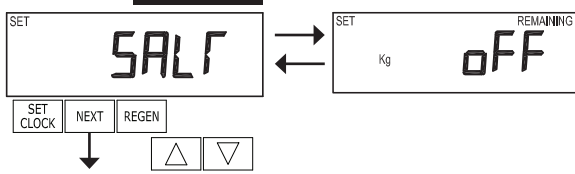

Step 16S – Set Low Salt Warning using ▲ or ▼. If value is set to:

- oFF, no low salt level warning will appear for the user; or
 - a specific value, “FILL SALT” will flash on the display when the calculated remaining kg of salt falls below that level. Allowable values range from 5 to 400 Kg in 5 Kg increments.
- Press NEXT to exit OEM Softener System Setup. Press REGEN to return to previous step.

RETURN TO NORMAL MODE

Setting Options Table

Filters should only use shaded options

Volume Capacity	Regeneration Time Option	Day Override	Result ¹
AUTO	NORMAL	oFF	Reserve capacity automatically estimated. Regeneration occurs when volume capacity falls below the reserve capacity at the next Regen Set Time.
AUTO	NORMAL	Any number	Reserve capacity automatically estimated. Regeneration occurs at the next Regen Set Time when volume capacity falls below the reserve capacity or the specified number of days between regenerations is reached.
Any number	NORMAL	oFF	Reserve capacity <u>not</u> automatically estimated. Regeneration occurs at the next Regen Set Time when volume capacity reaches 0.
oFF	NORMAL	Any number	Reserve capacity <u>not</u> automatically estimated. Regeneration occurs at the next Regen Set Time when the specified number of days between regenerations is reached.
Any number	NORMAL	Any number	Reserve capacity <u>not</u> automatically estimated. Regeneration occurs at the next Regen Set Time when volume capacity reaches 0 or the specified number of days between regenerations is reached.
AUTO	on 0	oFF	Reserve capacity <u>NOT</u> automatically estimated. Regeneration occurs immediately when volume capacity reaches 0. Time of regeneration will not be allowed to be set because regeneration will always occur when volume capacity reaches 0.
Any number	on 0	oFF	Reserve capacity <u>NOT</u> automatically estimated. Regeneration occurs immediately when volume capacity reaches 0. Time of regeneration will not be allowed to be set because regeneration will always occur on 0.
AUTO	NORMAL on 0	oFF	Reserve capacity automatically estimated. Regeneration occurs when volume capacity falls below the reserve capacity at the next Regen Set Time or regeneration occurs after 10 minutes of no water usage when volume capacity reaches 0.
AUTO	NORMAL on 0	Any number	Reserve capacity automatically estimated. Regeneration occurs at the next Regen Set Time when volume capacity falls below the reserve capacity or the specified number of days between regenerations is reached or regeneration occurs after 10 minutes of no water usage when volume capacity reaches 0.
Any number	NORMAL on 0	Any number	Reserve capacity <u>not</u> automatically estimated. Regeneration occurs at the next Regen Set Time when the specified number of days between regenerations is reached or regeneration occurs after 10 minutes of no water usage when volume capacity reaches 0.

¹ Reserve Capacity estimate is based on history of water usage. Reserve Capacity estimate is not available with alternator systems or Twin Tank Valve.

OEM Filter System Setup

In OEM Filter System Setup the OEM chooses the time for the cycles selected in OEM Cycle Sequence and specifies other operating parameters for the system. The upper and lower limits of the allowable values for the cycles are as follows:

Cycle Options	Units	Lower/Upper Limit
Backwash	Minutes	1 to 120
Rinse (fast)	Minutes	1 to 120
dn Brine (combination of regenerant and slow rinse)	Minutes	1 to 180
Fill for all valves except WS2	Liters	0.2 to 76.00
Fill for WS2 Valves	Minutes	0.01 to 99.0
Service	Minutes	1 to 480

NOTE: Fill is in liters (except for WS2).

Since no time is associated with the END cycle, the END cycle will not appear in the OEM Filter System Setup sequence.

STEP 1F

Step 1F – Press NEXT and ▼ simultaneously for 3 seconds and release. If screen in Step 2F does not appear in 5 seconds the lock on the valve is activated. To unlock press ▼, NEXT, ▲, and SET CLOCK in sequence, then press NEXT and ▼ simultaneously for 3 seconds and release.

STEP 2F

Step 2F – Choose FILTERING using ▲ or ▼. Press NEXT to go to Step 3F. Press REGEN to exit OEM Filter System Setup.

STEP 3F

Step 3F – Select the time for the first cycle (which in this example is BACKWASH) using ▲ or ▼. Press NEXT to go to Step 4F. Press REGEN to return to previous step.

STEP 4F

Step 4F – Select the time for the second cycle (which in this example is dn BRINE) using ▲ or ▼. Press NEXT to go to Step 5F. Press REGEN to return to previous step.
NOTE: The display will flash between cycle number and time, and brine direction (dn Brine).

STEP 5F

Step 5F – Select the time for the third cycle (which in this example is RINSE) using ▲ or ▼. Press NEXT to go to Step 6F. Press REGEN to return to previous step.

STEP 6F

Step 6F – Select the volume in liters for the fourth cycle (which in this example is FILL) using ▲ or ▼. When 2.0 is selected in Step 2CS, FILL is in minutes. WS2 valves are shipped from the factory with a refill flow control of 2.2 gpm (8.3 lpm). Press NEXT to go to Step 7F. Press REGEN to return to previous step.

STEP 7F

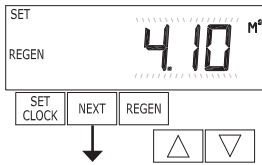

Step 7F – Set Volume Capacity using ▲ or ▼. If value is set to:

- oFF regeneration will be based solely on the day override set (see Installer Display/Settings Step 4I); or
- a number, regeneration initiation will be based off the value specified (in M³).

See Setting Options Table for more detail. Press NEXT to go to Step 8F. Press REGEN to return to previous step.

STEP 8F

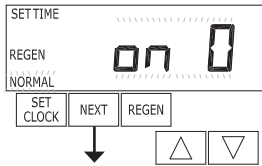

Step 8F – Set Regeneration Time Options using ▲ or ▼. If value is set to:

- NORMAL means regeneration will occur at the preset time;
- on 0 means regeneration will occur immediately when the volume capacity reaches 0 (zero); or
- NORMAL + on 0 means regeneration will occur at one of the following:
 - the preset time when the volume capacity falls below the reserve or the specified number of days between regenerations is reached whichever comes first;
 - or
 - immediately after 10 minutes of no water usage when the volume capacity reaches 0 (zero).

“NORMAL” is the default if Step 4CS is set to ALT A or ALT B, and “NORMAL + on 0” is not available.

On 0 is the default if Step 2CS is set to 1.0Γ, and NORMAL + on 0 is not available.

This step will not appear if Step 7F is set to “oFF”.

See Setting Options Table for more detail. Press NEXT to go to Step 9F. Press REGEN to return to previous step.

STEP 9F

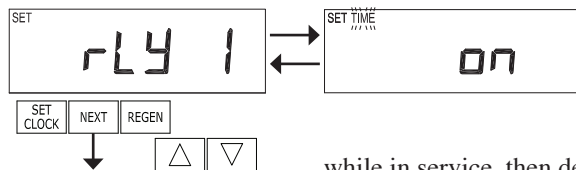

Step 9F – Set Relay 1 operation using ▲ or ▼. The choices are:

- Set Time on: Relay activates after a set time at the beginning of a regeneration cycle and then deactivates after a set period of time. The start of regeneration is defined as the first backwash cycle or Dn brine cycle, whichever comes first.
- Set L Filtering on: Relay activates after a set volume has been used while in service, then deactivates after the meter stops registering flow and the set time period has expired.

while in service, then deactivates after the meter stops registering flow and the set time period has expired.

- Set L Filtering Regen on: Relay activates after a set volume has been used while in service or during regeneration, then deactivates after the meter stops registering flow and the set time period has expired.
- Set Off: If set to Off, Steps 10F and 11F will not be shown.

Press NEXT to go to Step 10F. Press REGEN to return to previous step.

STEP 10F

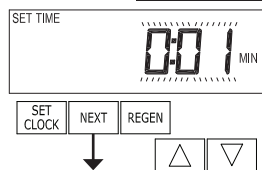

Step 10F – Set Relay 1 Actuation Time or Liters using ▲ or ▼. The choices are:

- Relay Actuation Time: After the start of a regeneration the amount of time that should pass prior to activating the relay. The start of regeneration is defined as the first backwash cycle or Dn brine cycle, whichever comes first. Ranges from 1 second to 200 minutes.
- Relay Actuation Liters: Relay activates after a set number of Liters has passed through the meter when the valve is in the Service mode. Ranges from 1 to 200 Liters.

Press NEXT to go to Step 11F. Press REGEN to return to previous step.

STEP 11F

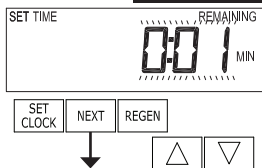

Step 11F – Set Relay 1 Deactivate Time using ▲ or ▼.

- If Set Time on is selected in Step 9F the relay will deactivate after the time set has expired. Ranges from 1 second to 200 minutes.
- If Set L on or Set L Filtering Regen on is selected in Step 9F the relay will deactivate after the time set has expired or after the meter stops registering flow, whichever comes first. Ranges from 1 second to 20 minutes.

Press NEXT to go to Step 12F. Press REGEN to return to previous step.

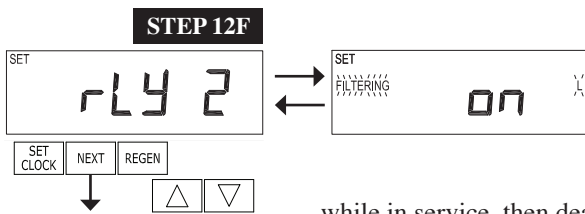

Step 12F – Set Relay 2 operation using ▲ or ▼. The choices are:

- Set Time on: Relay activates after a set time at the beginning of a regeneration cycle and then deactivates after a set period of time. The start of regeneration is defined as the first backwash cycle or Dn brine cycle, whichever comes first.
- Set L Filtering on: Relay activates after a set volume has been used

while in service, then deactivates after the meter stops registering flow and the set time period has expired.

- Set L Filtering Regen on: Relay activates after a set volume has been used while in service or during regeneration, then deactivates after the meter stops registering flow and the set time period has expired.
- Error: Relay closes whenever the control enters the Error Mode, and immediately deactivates when the error mode is exited.
- Set Off: If set to Off, Steps 13F and 14F will not be shown.

Press NEXT to go to Step 13F. Press REGEN to return to previous step.

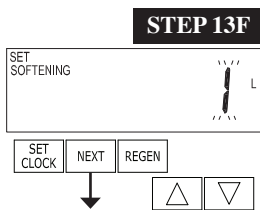

Step 13F – Set Relay 2 Actuation Time or Liters using ▲ or ▼. The choices are:

- Relay Actuation Time: After the start of a regeneration the amount of time that should pass prior to activating the relay. The start of regeneration is defined as the first backwash cycle or Dn brine cycle, whichever comes first. Ranges from 1 second to 200 minutes.
- Relay Actuation Liters: Relay activates after a set number of Liters has passed through the meter when the valve is in the Service mode. Ranges from 1 to 200 Liters.

Press NEXT to go to Step 14F. Press REGEN to return to previous step.

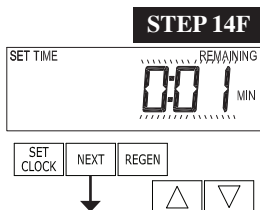

Step 14F – Set Relay 2 Deactivate Time using ▲ or ▼.

- If Set Time on is selected in Step 13S the relay will deactivate after the time set has expired. Ranges from 1 second to 200 minutes.
- If Set L on or Set L Softening Regen on is selected in Step 13S the relay will deactivate after the time set has expired or after the meter stops registering flow, whichever comes first. Ranges from 1 second to 20 minutes.

Press NEXT to go to exit OEM Filter System Setup. Press REGEN to return to previous step.

RETURN TO NORMAL MODE

Installer Display Settings

STEP 1I

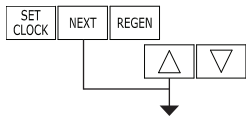

STEP 1I - Press NEXT and ▲ simultaneously for 3 seconds.

STEP 2I

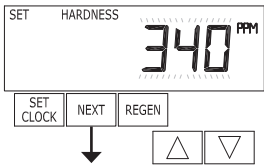

STEP 2I – Hardness: Set the amount of influent hardness using ▲ or ▼. This display will not be shown if FILTER is selected in Step 2F OR if oFF or a number was selected in Step 8S. Press NEXT to go to step 3I. Press REGEN to exit Installer Display Settings.

Units Available
PPM
FH
dH

STEP 3I

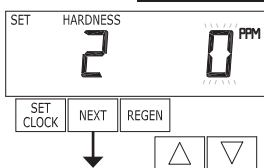

STEP 3I – Service Water Hardness - If a mixing valve is installed in the valve, service hardness needs to be set. Setting range is always less than the setting in Step 2I. This screen will not be displayed when valve is set as a Filter, or if Auto is not selected in Step 8S. Press NEXT to go to Step 4I. Press REGEN to return to previous step.

STEP 4I

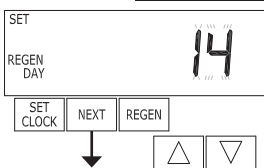

STEP 4I – Day Override: When volume capacity is set to oFF, sets the number of days between regenerations. When volume capacity is set to AUTO or to a number, sets the maximum number of days between regenerations. If value set to oFF, regeneration initiation is based solely on volume used. If value is set as a number (allowable range from 1 to 28) a regeneration initiation will be called for on that day even if sufficient volume of water were not used to call for a regeneration. Set Day Override using ▲ or ▼:

- number of days between regeneration (1 to 28); or
- oFF.

See Setting Options Table for more detail on setup. Press NEXT to go to step 5I. Press REGEN to return to previous step.

STEP 5I

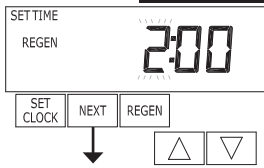

STEP 5I – Next Regeneration Time (hour): Set the hour of day for regeneration using ▲ or ▼ buttons. The default time is 2:00. This display will show “REGEN on 0 m” if “on 0” is selected in Set Regeneration Time Option in OEM Softener System Setup or OEM Filter System Setup. Press NEXT to go to step 6I. Press REGEN to return to previous step.

STEP 6I

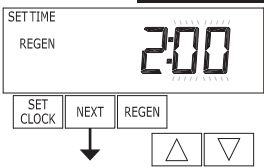

STEP 6I – Next Regeneration Time (minutes): Set the minutes of day for regeneration using ▲ or ▼. This display will not be shown if “on 0” is selected in Set Regeneration Time Option in OEM Softener System Setup or OEM Filter System Setup. Press NEXT to exit Installer Display Settings. Press REGEN to return to previous step.

RETURN TO NORMAL MODE

To initiate a manual regeneration immediately, press and hold the REGEN button for three seconds. The system will begin to regenerate immediately. The control valve may be stepped through the various regeneration cycles by pressing the REGEN button.

User Display Settings

General Operation

When the system is operating, one of five displays may be shown. Pressing NEXT will alternate between the displays. One of the displays is always the current time of day. The second display is one of the following: days remaining or volume remaining. Days remaining is the number of days left before the system goes through a regeneration cycle. Capacity remaining is the cubic meters that will be treated before the system goes through a regeneration cycle. The third display shows the current treated water flow rate through the system. If 1.0 Γ is selected in Step 2CS, an “A” in front of the flow rate indicates that the tank with the control valve on it is in service. If “b” is displayed, the tank with the in/out head is in service. The fourth display will show either dP or hold if the dP switch is closed. The fifth display shows the kg of salt remaining or flashes “SALT” fill when the calculated kg of salt falls below a safety level. The fifth display will not appear if the valve is a WS2, set up as a filter or if the Set Low Salt Warning is set to off (see last step in OEM Softener System Setup). The user can scroll between the displays as desired.

If the system has called for a regeneration that will occur at the preset time of regeneration, the words REGEN TODAY will appear on the display.

If a water meter is installed, the word “Softening” or “Filtering” flashes on the display when water is being treated (i.e. water is flowing through the system).

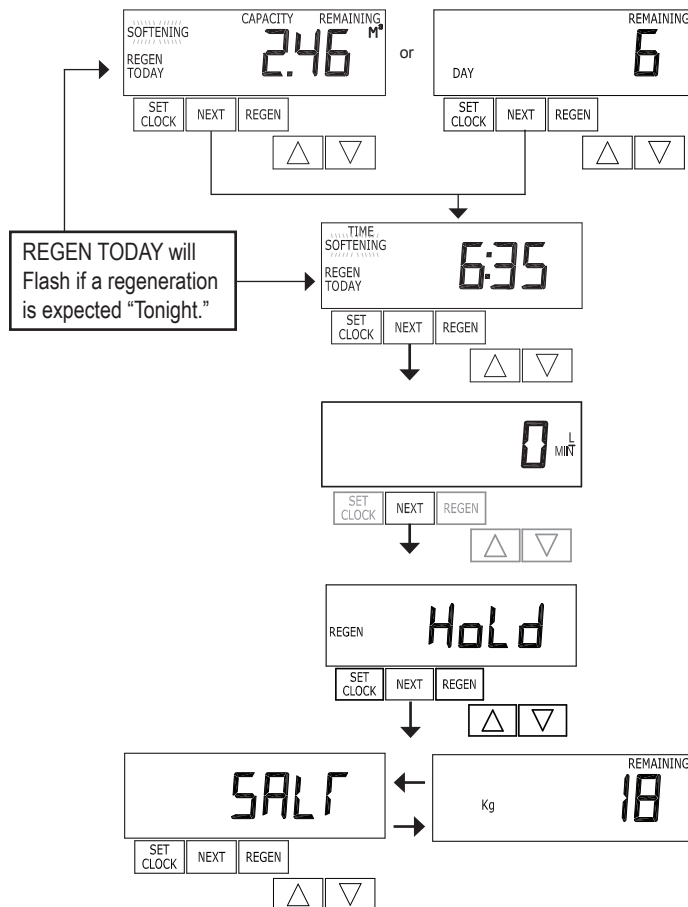

In Alternator Systems when a unit is waiting to initiate the first cycle step of regeneration, “REGEN Pndg” is displayed.



“STbY” is displayed in Alternator Systems when a valve is in Standby state.

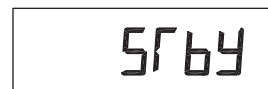

“REGEN Pndg FILL RINSE” is displayed whenever a zero-capacity tank has transferred to an off-line state and is currently waiting to initiate the second portion of a regeneration cycle. Viewed only when Delayed Rinse and Fill is set to ON.



Regeneration Mode

Typically a system is set to regenerate at a time of low water usage. An example of a time with low water usage is when a household is asleep. If there is a demand for water when the system is regenerating, untreated water will be used.



When the system begins to regenerate, the display will change to include information about the step of the regeneration process and the time remaining for that step to be completed. The system runs through the steps automatically and will reset itself to provide treated water when the regeneration has been completed.

Manual Regeneration

Sometimes there is a need to regenerate the system sooner than when the system calls for it, usually referred to as manual regeneration. There may be a period of heavy water usage because of guests or a heavy laundry day.

REGEN TODAY will be displayed if a regeneration is expected "Tonight."

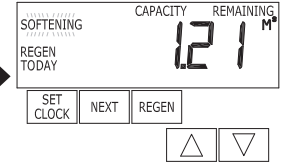

To initiate a manual regeneration at the preset delayed regeneration time, when the regeneration time option is set to "NORMAL" or "NORMAL + on 0", press and release "REGEN". The words "REGEN TODAY" will flash on the display to indicate that the system will regenerate at the preset delayed regeneration time. If you pressed the "REGEN" button in error, pressing the button again will cancel the request. Note: If the regeneration time option is set to "on 0" there is no set delayed regeneration time so "REGEN TODAY" will not activate if "REGEN" button is pressed.

To initiate a manual regeneration immediately, press and hold the "REGEN" button for three seconds. The system will begin to regenerate immediately. The request cannot be cancelled.

Note: For softeners, if brine tank does not contain salt, fill with salt and wait at least two hours before regenerating.

Set Time of Day

The user can also set the time of day. Time of day should only need to be set after power outages lasting more than 24 hours, if the battery has been depleted and a power outage occurs or when daylight saving time begins or ends. If a power outage lasting more than 24 hours occurs, the time of day will flash on and off which indicates the time of day should be reset. If a power outage lasts less then 24 hours and the time of day flashes on and off, the time of day should be reset and the non rechargeable battery replaced.

STEP 1U

STEP 1U – Press SET CLOCK.

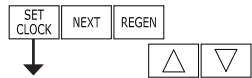

STEP 2U

STEP 2U - Current Time (hour): Set the hour of the day using ▲ or ▼. Press NEXT to go to Step 3U.

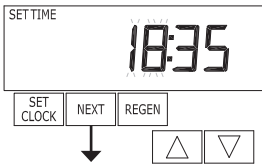

STEP 3U

STEP 3U - Current Time (minutes): Set the minutes of the day using ▲ or ▼. Press NEXT to exit Set Clock. Press REGEN to return to previous step.

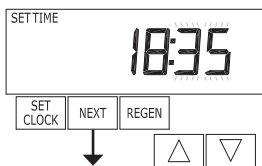

RETURN TO NORMAL MODE

Salt Remaining or Adding Salt (not available for WS2 valves)

If the Low Salt Warning was activated in the last step of OEM Softener System Setup the following screens will be viewed in the User Display.

Note: The salt used per regeneration setting can be set in increments of 0.05 Kg, but the Kg REMAINING screen will round up or down to the closest whole number.

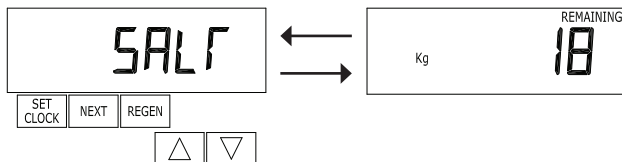

Once the salt remaining has gone below the set point the display will automatically flash Salt Fill.



When adding salt to the brine tank (if the salt remaining feature is activated) the following steps must be completed:

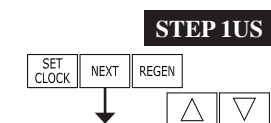

Step 1US – Press the NEXT button until SALT appears in the display. It does not matter if the SALT display alternates with the Kg REMAINING display.

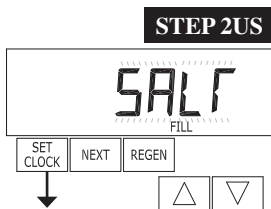

Step 2US – Press SET CLOCK.

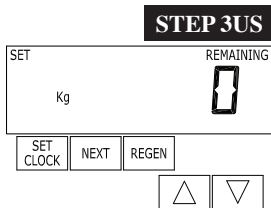

Step 3US – Set Kg REMAINING: Use ▲ or ▼ to adjust the Kg remaining in the brine tank.



NOTE: Estimate the Kg of salt in the brine tank and add it to the amount of salt added to the brine tank. The example at the left would indicate 100 Kg of salt being added to a brine tank that has 20 Kg remaining.

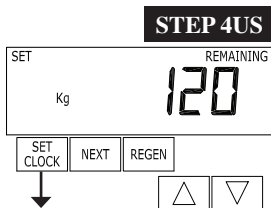

Step 4US – Press SET CLOCK or NEXT to exit Adding Salt.

RETURN TO NORMAL MODE

Power Loss

If the power goes out, the system will keep time for 24 hours or until the battery is depleted. If a power outage of more than 24 hours occurs, the time of day will flash on and off which indicates the time of day should be reset. The system will remember the rest. If a power outage lasts less than 24 hours and the time of day flashes on and off, the time of day should be reset and the non rechargeable battery replaced.

Error Message

If the word “ERROR” and a number are alternately flashing on the display contact the OEM for help. This indicates that the valve was not able to function properly.

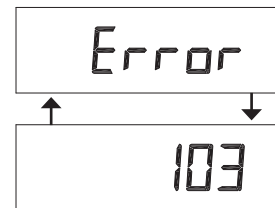

Diagnostics

STEP 1D

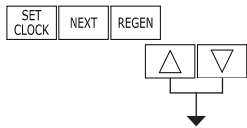

STEP 1D – Press ▲ and ▼ simultaneously for three seconds. If screen in step 2D does not appear in 5 seconds the lock on the valve is activated. To unlock press ▼, NEXT, ▲, and SET CLOCK in sequence, then press ▲ and ▼ simultaneously for 3 seconds.

STEP 2D

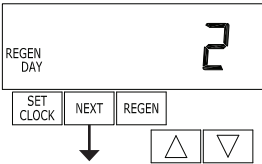

STEP 2D – Days, since last regeneration: This display shows the days since the last regeneration occurred. Press NEXT to go to Step 3D. Press REGEN to exit Diagnostics.

STEP 3D

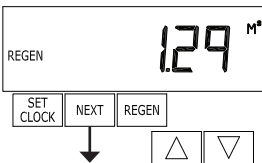

STEP 3D – Volume, since last regeneration: This display shows the volume of water that has been treated since the last regeneration. This display will equal zero if a water meter is not installed. Press NEXT to go to Step 4D. Press REGEN to return to previous step.

STEP 4D

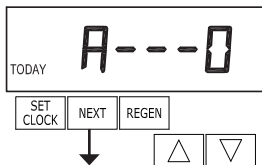

STEP 4D – Volume, reserve capacity used for last 7 days: If the valve is set up as a softener, a meter is installed and Set Volume Capacity is set to “Auto,” this display shows 0 day (for today) and flashes the reserve capacity. Pressing ▲ will show day 1 (which would be yesterday) and flashes the reserve capacity used. Pressing ▲ again will show day 2 (the day before yesterday) and the reserve capacity. Keep pressing ▲ to show the capacity for days 3, 4, 5 and 6. ▼ can be pressed to move backwards in the day series. Display does not appear if 1.0Γ is selected in Step 2CS. Press NEXT at any time to go to Step 5D. Press REGEN to return to previous step.



STEP 5D

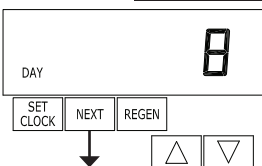

STEP 5D - Volume, 63-day usage history: This display shows day 1 (for yesterday) and flashes the volume of water treated yesterday. Pressing ▲ will show day 2 (which would be the day before yesterday) and flashes the volume of water treated on that day. Continue to press ▲ to show the maximum volume of water treated for the last 63 days. If a regeneration occurred on the day the word “REGEN” will also be displayed. This display will show dashes if a water meter is not installed. Press NEXT at any time to go to Step 6D. Press REGEN to return to previous step.



STEP 6D

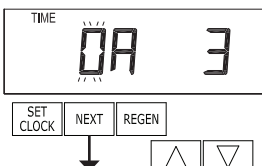

STEP 6D – Twin Tank Valve Transfer History only displays when 1.0Γ was selected in Step 2CS. Use ▲ or ▼ to scroll through the last 10 tank transfers.

The first position in the display ranges from 0 to 9 with the lowest number being the most recent transfer. The second position in the display will be either “A” or “b”. If “A” then the tank with the valve on it was in service, if “b” the tank with the in/out head on it was in service. The next three digits represent the number of hours ago that the transfer occurred. The display alternates with the volume that was treated before the tank transferred. Press NEXT at any time to go to Step 7D. Press REGEN to return to previous step.



STEP 7D

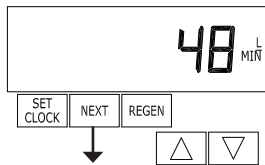

STEP 7D – Flow rate, maximum last seven days: The maximum flow rate in liters per minute that occurred in the last seven days will be displayed. This display will equal zero if a water meter is not installed. Press NEXT to go to Step 8D. Press REGEN to return to previous step.

STEP 8D

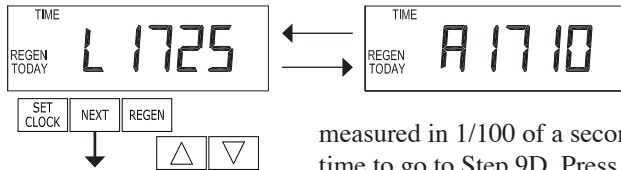

STEP 8D – MAV Drive History in the direction of extended piston rod position. Display will not be shown if 1.0Γ is not selected in Step 2CS and OFF is selected in Step 4CS. If the display does appear up to a four digit number will appear after the “L” which stands for latest and “A” which stands for average. Drive time is measured in 1/100 of a second; i.e., a 17.10 second move is displayed as 1710. Press NEXT at any time to go to Step 9D. Press REGEN to return to previous step.

Press and hold ▲ and ▼ buttons for 3 seconds while in Step 8D to reset the MAV drive history in both the retracted and extended piston rod position. To view the old MAV drive history data for retracted and extended rod position press and hold SET CLOCK and ▲ while in Step 8D. Press NEXT to advance display to the old MAV drive history.

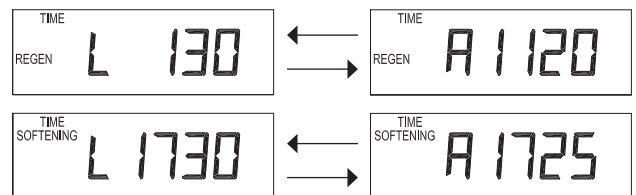

STEP 9D

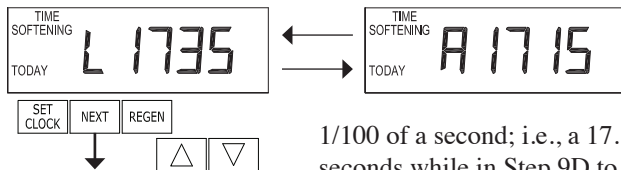

STEP 9D – MAV Drive History in the direction of retracted piston rod position. Display will not be shown if 1.0Γ is not selected in Step 2CS and OFF is selected in Step 4CS. If the display does appear, up to a four digit number will appear after the “L” which stands for latest and “A” which stands for average. Drive time is measured in 1/100 of a second; i.e., a 17.15 second move is displayed as 1715. Press and hold ▲ and ▼ for 3 seconds while in Step 9D to reset the MAV drive history in both the extended and retracted piston rod position. To view the old MAV drive history data see Step 8D. Press the NEXT button at any time exit Diagnostics. Press REGEN to return to previous step.

RETURN TO NORMAL MODE

When desired, all programming and all information in Diagnostics may be reset to defaults when the valve is installed in a new location. To reset to defaults, press NEXT and ▼ buttons simultaneously to go to the Softening/Filtering screen. Press ▲ and ▼ simultaneously to reset diagnostic values and all programming to defaults. Screen will return to User Display.

Valve History

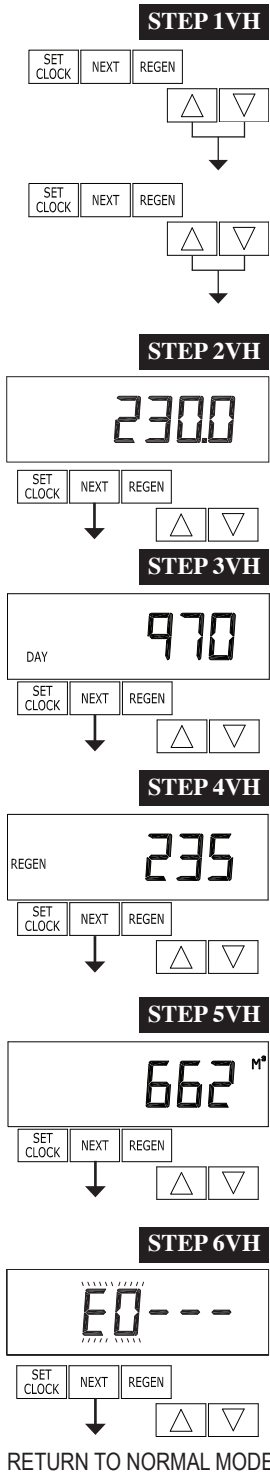

STEP 1VH – Press ▲ and ▼ simultaneously for three seconds and release. Then press ▲ and ▼ simultaneously and release. If screen in step 2VH does not appear in 5 seconds the lock on the valve is activated. To unlock press ▼, NEXT, ▲, and SET CLOCK in sequence, then press ▲ and ▼ simultaneously for 3 seconds and release. Then press ▲ and ▼ simultaneously and release.

STEP 2VH² – Software version: This display shows the software version of the valve. Press the NEXT button to go to Step3VH. Press REGEN to exit the valve history.

STEP 3VH – Days, total since start-up: This display shows the total days since startup. Press the NEXT button to go to Step 4VH. Press REGEN to return to previous step.

STEP 4VH – Regenerations, total number since start-up: This display shows the total number of regenerations that have occurred since startup. Press the NEXT button to go to Step 5VH. Press REGEN to return to previous step.

STEP 5VH – Volume, total used since start-up: This display shows the total volume of water treated since startup. This display will equal zero if a water meter is not installed. Press the NEXT button to go to Step 6VH. Press REGEN to return to previous step.

STEP 6VH – Error Log: This display shows a history of the last 10 errors generated by the control during operation. Press the ▲ or ▼ buttons to view each recorded error. Press the next button to exit Valve History. Press REGEN to return to previous step.

² Values in steps 2VH through 6VH cannot be reset.

Revision History:

8/20/2018

PAGE 10:

Inserted a new Step 12S - Battery Operation

10/10/2018

PAGE 4:

Update Power Supply information

4/23/2020

PAGE 4:

Removed #7 V3106-01 from table and drawing.

Not Shown	V3186-06	WS1 POWER SUPPLY US 15VDC HOCP	1
	V3186EU-06	WS1 POWER SUPPLY EU 15VDC HOCP	
	V3186UK-06	WS1 POWER SUPPLY UK 15VDC HOCP	
	V3186-01	WS1 POWER CORD ONLY	

